

-

Stone No 75858

Shape EMERALD

Real Weight 10.77 (Ct)

Width 10.12 (mm)

Length 16.32 (mm)

Total Height 63.33 (%) 6.410(mm)

Table 70.00 (%) 7.050(mm)

L/W Ratio 1.61

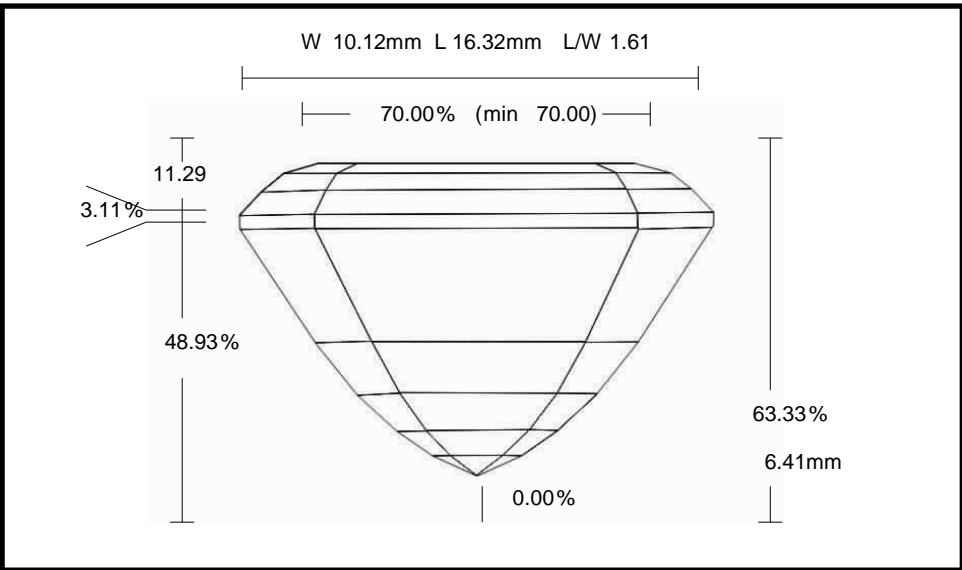

Parameter		Avg	Min	Max	Dev
Crown Angle 1	%	25.12	25.04	25.21	0.17
Crown Height	%	11.29	11.01	11.40	0.39
Girdle Thickness	%	3.11	2.62	3.30	0.68
Pavilion Angle 1 (Main)	%	58.82	58.68	58.97	0.29
Pavilion Height	%	48.93	48.62	49.33	0.71