

-

Stone No 73846

Shape EMERALD

Real Weight 5.45 (Ct)

Width 8.30 (mm)

Length 13.07 (mm)

Total Height 58.16 (%) 4.830(mm)

Table 73.00 (%) 6.050(mm)

L/W Ratio 1.57

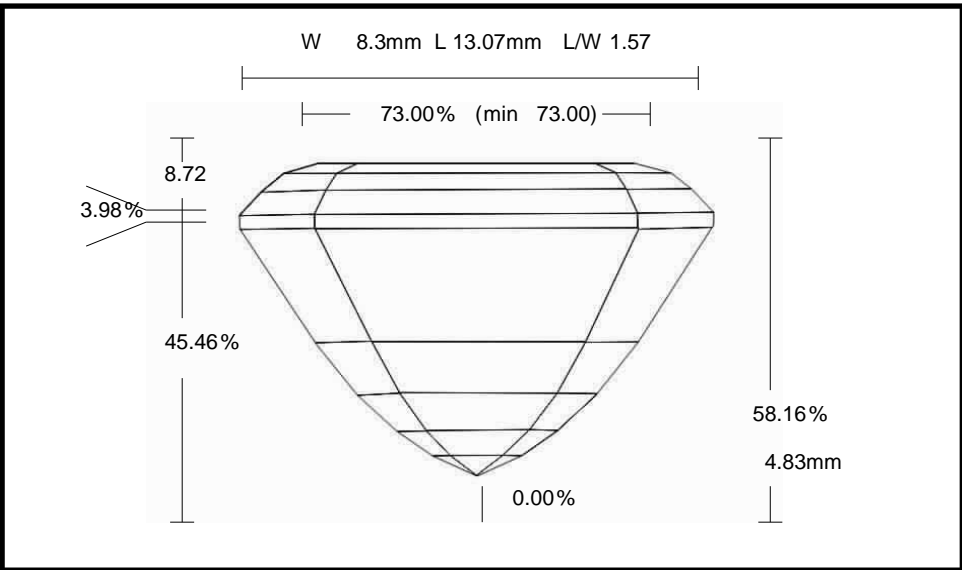

| Parameter | | Avg | Min | Max | Dev |
|--------------------------------|---|-------|-------|-------|------|
| Crown Angle 1 | % | 14.61 | 14.28 | 14.95 | 0.67 |
| Crown Height | % | 8.72 | 8.12 | 9.07 | 0.95 |
| Girdle Thickness | % | 3.98 | 3.80 | 4.40 | 0.60 |
| Pavilion Angle 1 (Main) | % | 56.75 | 56.25 | 57.26 | 1.01 |
| Pavilion Height | % | 45.46 | 45.19 | 45.63 | 0.44 |