

-

**Stone No** 73820  
**Shape** EMERALD  
**Real Weight** 8.00 ( Ct )  
**Width** 9.21 ( mm )  
**Length** 14.62 ( mm )  
**Total Height** 62.82 (%) 5.780(mm)  
**Table** 72.00 (%) 6.660(mm)  
**L/W Ratio** 1.59

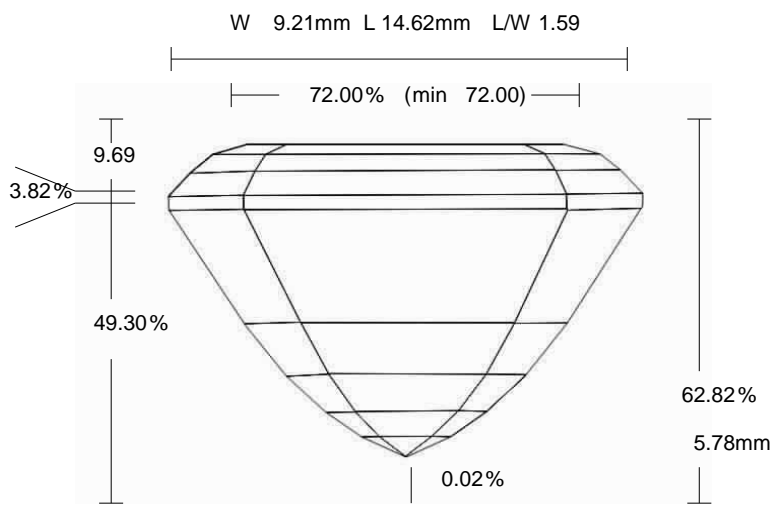

Parameter		Avg	Min	Max	Dev
<b>Crown Angle 1</b>	%	20.65	19.87	21.42	1.55
<b>Crown Height</b>	%	9.69	9.46	9.94	0.48
<b>Girdle Thickness</b>	%	3.82	3.66	3.97	0.31
<b>Pavilion Angle 1 (Main)</b>	%	58.05	56.86	59.25	2.39
<b>Pavilion Height</b>	%	49.30	48.91	49.59	0.68