

-

**Stone No** 72407  
**Shape** EMERALD  
**Real Weight** 8.56 ( Ct )  
**Width** 9.62 ( mm )  
**Length** 14.74 ( mm )  
**Total Height** 63.82 (%) 6.140(mm)  
**Table** 63.00 (%) 6.040(mm)  
**L/W Ratio** 1.53

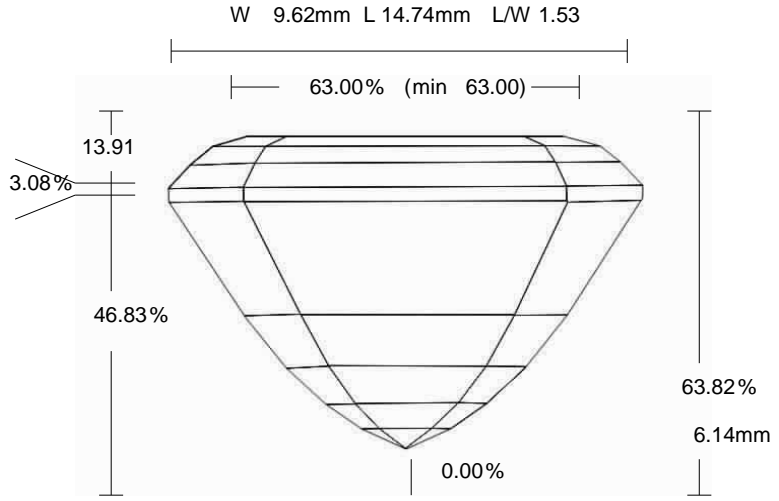

Parameter		Avg	Min	Max	Dev
Crown Angle 1	%	27.50	25.61	29.39	3.78
Crown Height	%	13.91	13.20	14.66	1.46
Girdle Thickness	%	3.08	2.89	3.18	0.29
Pavilion Angle 1 (Main)	%	55.18	54.67	55.69	1.02
Pavilion Height	%	46.83	46.04	47.73	1.69