

-

Stone No 72359

Shape EMERALD

Real Weight 13.00 (Ct)

Width 10.50 (mm)

Length 17.12 (mm)

Total Height 67.73 (%) 7.120(mm)

Table 55.00 (%) 5.730(mm)

L/W Ratio 1.63

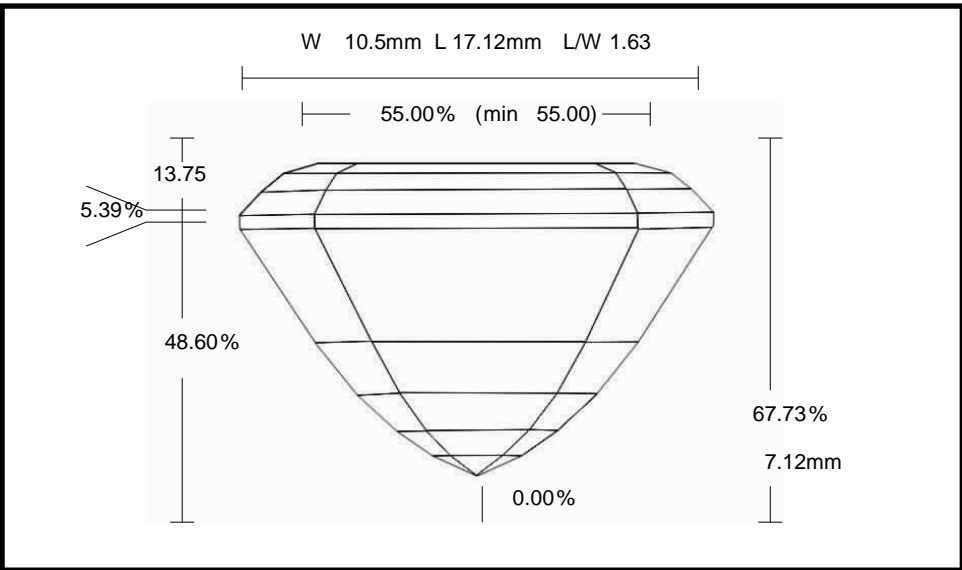

Parameter		Avg	Min	Max	Dev
Crown Angle 1	%	18.46	18.00	18.92	0.92
Crown Height	%	13.75	13.35	14.02	0.67
Girdle Thickness	%	5.39	5.18	5.67	0.49
Pavilion Angle 1 (Main)	%	57.66	57.52	57.79	0.27
Pavilion Height	%	48.60	48.26	49.14	0.88