

-

Stone No 72352

Shape EMERALD

Real Weight 11.27 (Ct)

Width 9.92 (mm)

Length 16.30 (mm)

Total Height 67.20 (%) 6.670(mm)

Table 69.00 (%) 6.870(mm)

L/W Ratio 1.64

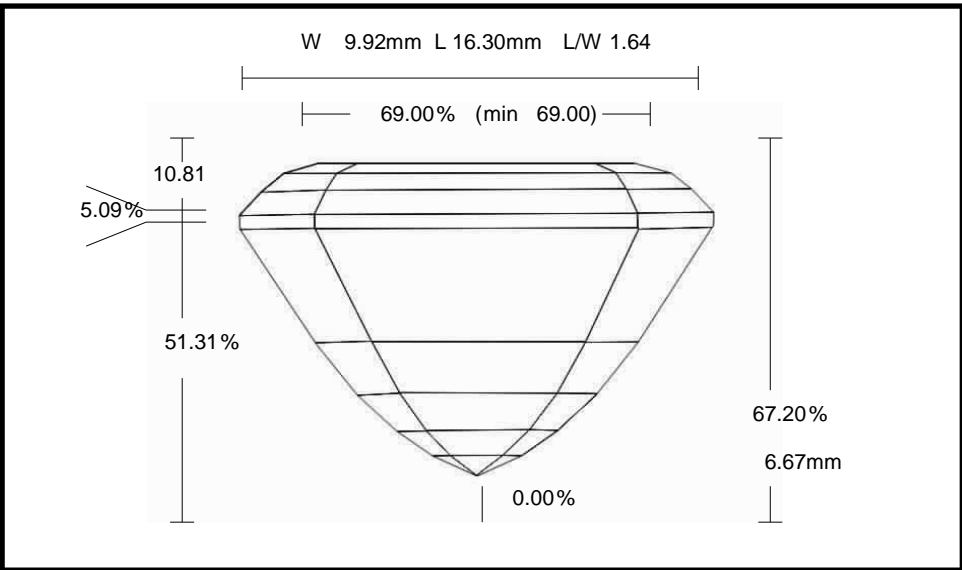

Parameter		Avg	Min	Max	Dev
Crown Angle 1	%	24.12	24.04	24.21	0.17
Crown Height	%	10.81	10.58	11.12	0.54
Girdle Thickness	%	5.09	3.59	5.66	2.07
Pavilion Angle 1 (Main)	%	58.81	58.76	58.86	0.10
Pavilion Height	%	51.31	50.52	52.82	2.30