

-

Stone No 72351

Shape EMERALD

Real Weight 7.47 (Ct)

Width 8.62 (mm)

Length 14.25 (mm)

Total Height 69.55 (%) 6.000(mm)

Table 59.00 (%) 5.050(mm)

L/W Ratio 1.65

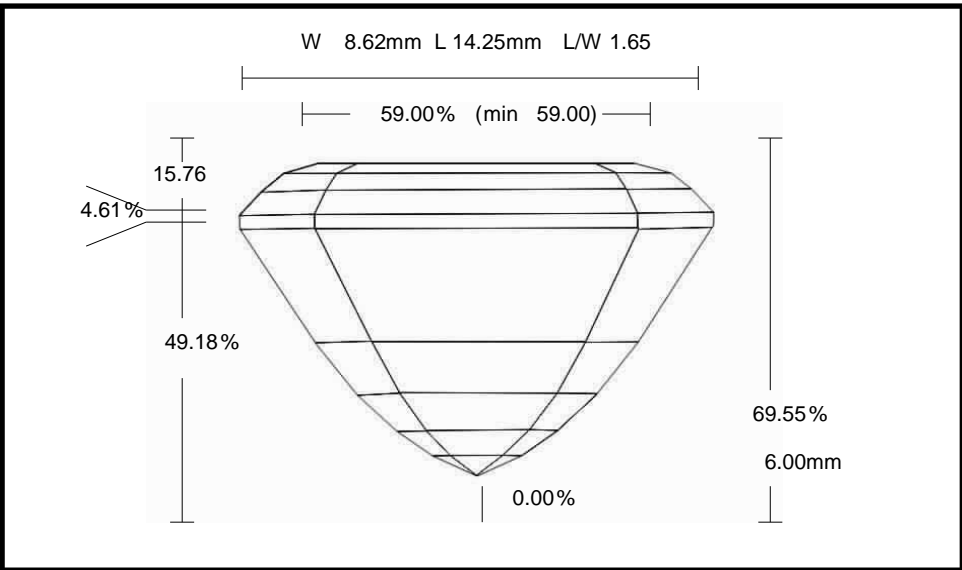

Parameter		Avg	Min	Max	Dev
Crown Angle 1	%	31.91	31.16	32.66	1.50
Crown Height	%	15.76	15.52	16.08	0.56
Girdle Thickness	%	4.61	4.47	4.70	0.23
Pavilion Angle 1 (Main)	%	58.08	58.00	58.17	0.17
Pavilion Height	%	49.18	49.00	49.33	0.33