

-

Stone No 72341

Shape EMERALD

Real Weight 7.68 (Ct)

Width 8.72 (mm)

Length 14.31 (mm)

Total Height 68.48 (%) 5.970(mm)

Table 59.00 (%) 5.130(mm)

L/W Ratio 1.64

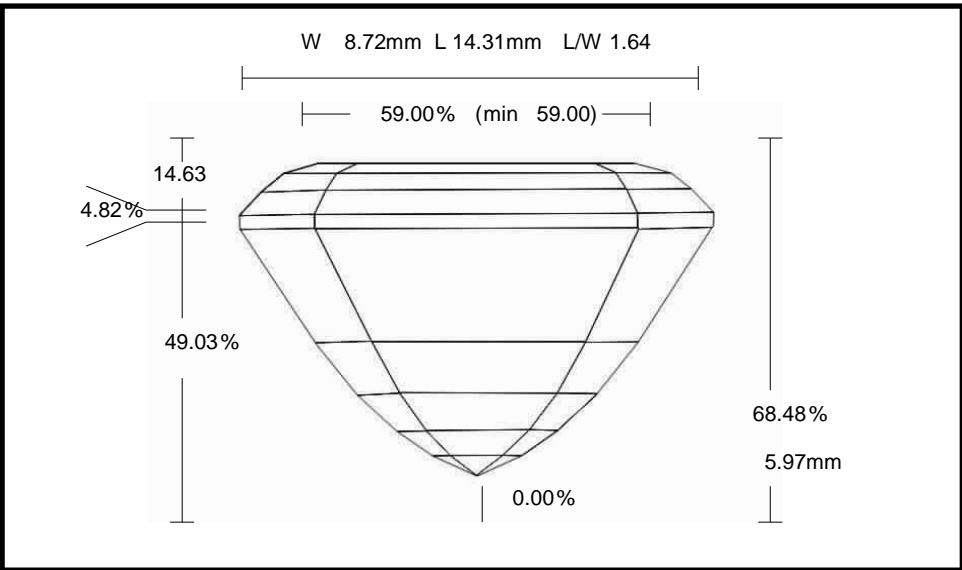

Parameter		Avg	Min	Max	Dev
Crown Angle 1	%	27.18	26.58	27.77	1.19
Crown Height	%	14.63	14.60	14.66	0.06
Girdle Thickness	%	4.82	4.59	5.16	0.57
Pavilion Angle 1 (Main)	%	59.22	59.15	59.29	0.14
Pavilion Height	%	49.03	48.68	49.28	0.60