

-

**Stone No** 72270

**Shape** EMERALD

**Real Weight** 11.05 ( Ct )

**Width** 10.24 ( mm )

**Length** 16.66 ( mm )

**Total Height** 62.01 (%) 6.350(mm)

**Table** 69.00 (%) 7.070(mm)

**L/W Ratio** 1.63

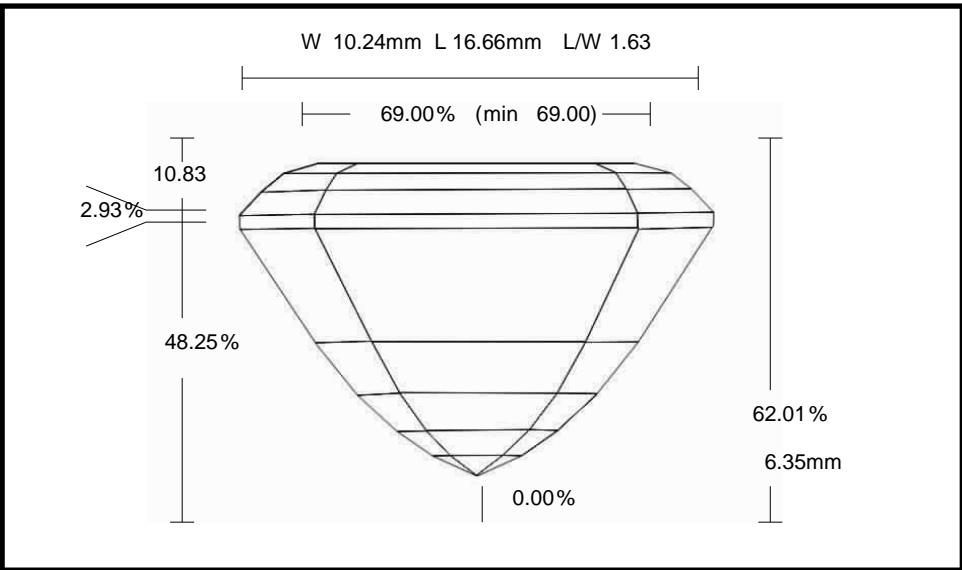

Parameter		Avg	Min	Max	Dev
<b>Crown Angle 1</b>	%	25.25	25.19	25.30	0.11
<b>Crown Height</b>	%	10.83	10.53	11.03	0.50
<b>Girdle Thickness</b>	%	2.93	2.82	3.08	0.26
<b>Pavilion Angle 1 (Main)</b>	%	59.65	59.48	59.82	0.34
<b>Pavilion Height</b>	%	48.25	47.97	48.57	0.60