

-

Stone No 72261

Shape EMERALD

Real Weight 11.09 (Ct)

Width 9.89 (mm)

Length 16.30 (mm)

Total Height 66.71 (%) 6.600(mm)

Table 67.00 (%) 6.610(mm)

L/W Ratio 1.65

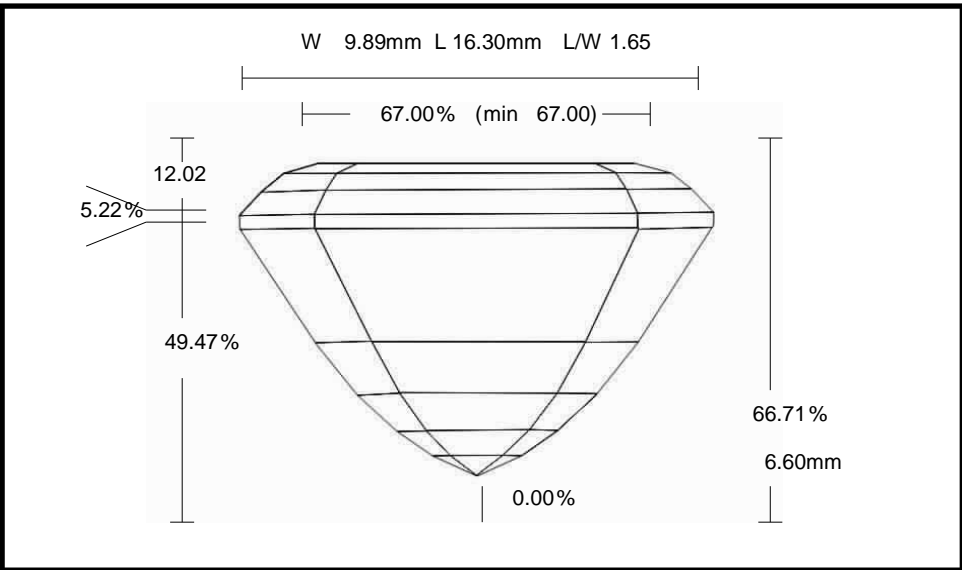

Parameter		Avg	Min	Max	Dev
Crown Angle 1	%	23.14	22.47	23.81	1.34
Crown Height	%	12.02	11.89	12.17	0.28
Girdle Thickness	%	5.22	5.04	5.50	0.46
Pavilion Angle 1 (Main)	%	57.53	57.11	57.95	0.84
Pavilion Height	%	49.47	49.29	49.65	0.36