

-

**Stone No** 72259

**Shape** EMERALD

**Real Weight** 12.08 ( Ct )

**Width** 10.39 ( mm )

**Length** 16.86 ( mm )

**Total Height** 64.40 (%) 6.690(mm)

**Table** 68.00 (%) 7.030(mm)

**L/W Ratio** 1.62

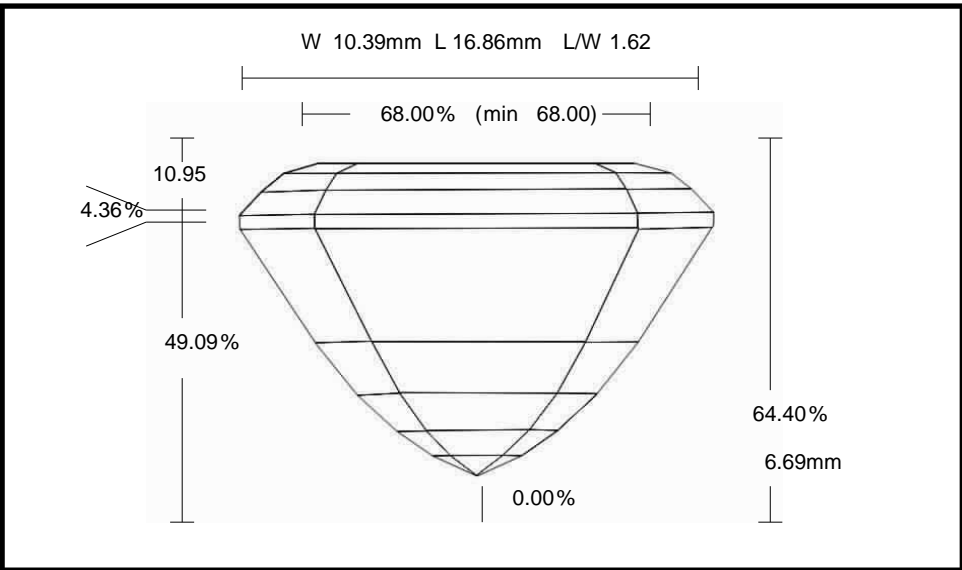

Parameter		Avg	Min	Max	Dev
<b>Crown Angle 1</b>	%	21.96	21.78	22.14	0.36
<b>Crown Height</b>	%	10.95	10.54	11.23	0.69
<b>Girdle Thickness</b>	%	4.36	4.17	4.64	0.47
<b>Pavilion Angle 1 (Main)</b>	%	58.03	57.93	58.13	0.20
<b>Pavilion Height</b>	%	49.09	48.92	49.22	0.30