

-

Stone No 72245

Shape EMERALD

Real Weight 12.29 (Ct)

Width 10.71 (mm)

Length 17.04 (mm)

Total Height 62.38 (%) 6.680(mm)

Table 69.00 (%) 7.410(mm)

L/W Ratio 1.59

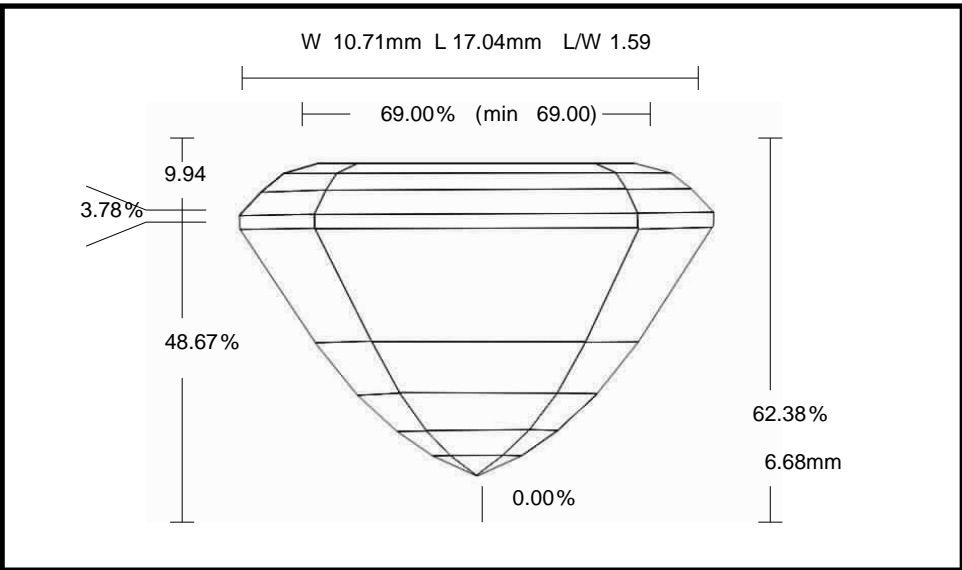

Parameter		Avg	Min	Max	Dev
Crown Angle 1	%	22.09	21.76	22.42	0.66
Crown Height	%	9.94	9.86	10.06	0.20
Girdle Thickness	%	3.78	3.74	3.84	0.10
Pavilion Angle 1 (Main)	%	57.06	56.96	57.17	0.21
Pavilion Height	%	48.67	48.58	48.74	0.16