

-

Stone No 72243

Shape EMERALD

Real Weight 13.07 (Ct)

Width 10.56 (mm)

Length 17.35 (mm)

Total Height 64.41 (%) 6.800(mm)

Table 73.00 (%) 7.660(mm)

L/W Ratio 1.64

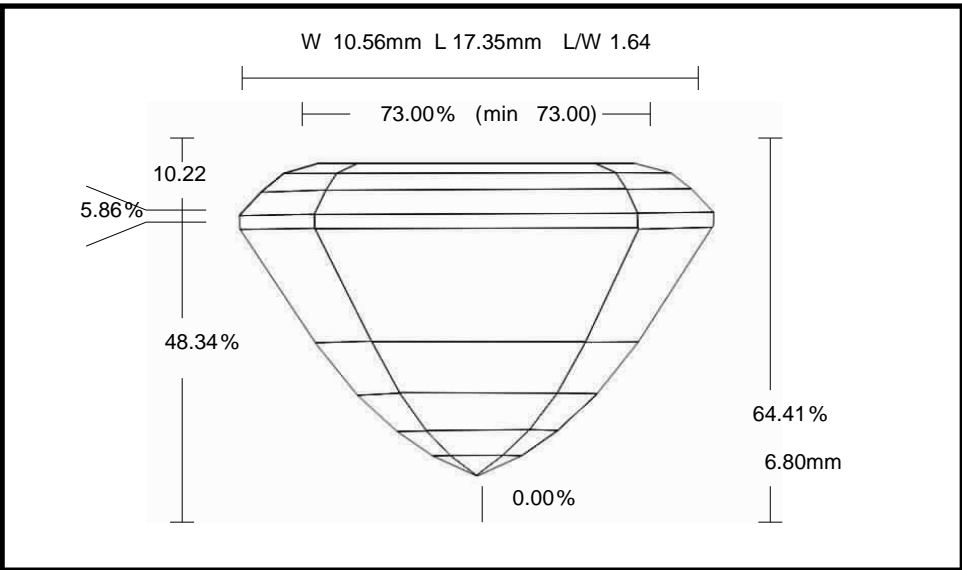

Parameter		Avg	Min	Max	Dev
Crown Angle 1	%	30.90	30.85	30.94	0.09
Crown Height	%	10.22	9.81	10.72	0.91
Girdle Thickness	%	5.86	5.52	6.18	0.66
Pavilion Angle 1 (Main)	%	58.32	58.11	58.53	0.42
Pavilion Height	%	48.34	47.94	48.84	0.90