

-

Stone No 72197

Shape EMERALD

Real Weight 12.14 (Ct)

Width 10.33 (mm)

Length 16.63 (mm)

Total Height 66.27 (%) 6.850(mm)

Table 68.00 (%) 7.070(mm)

L/W Ratio 1.61

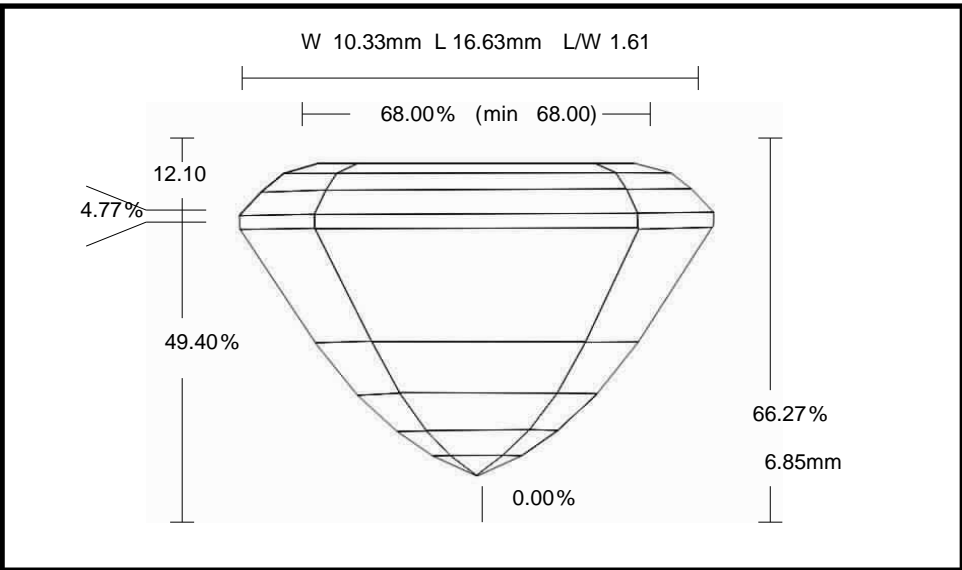

Parameter		Avg	Min	Max	Dev
Crown Angle 1	%	27.75	27.74	27.75	0.01
Crown Height	%	12.10	11.94	12.23	0.29
Girdle Thickness	%	4.77	4.58	4.87	0.29
Pavilion Angle 1 (Main)	%	58.47	58.16	58.78	0.62
Pavilion Height	%	49.40	49.17	49.65	0.48