

-

Stone No 72178

Shape EMERALD

Real Weight 7.48 (Ct)

Width 9.13 (mm)

Length 13.05 (mm)

Total Height 68.04 (%) 6.210(mm)

Table 71.00 (%) 6.500(mm)

L/W Ratio 1.43

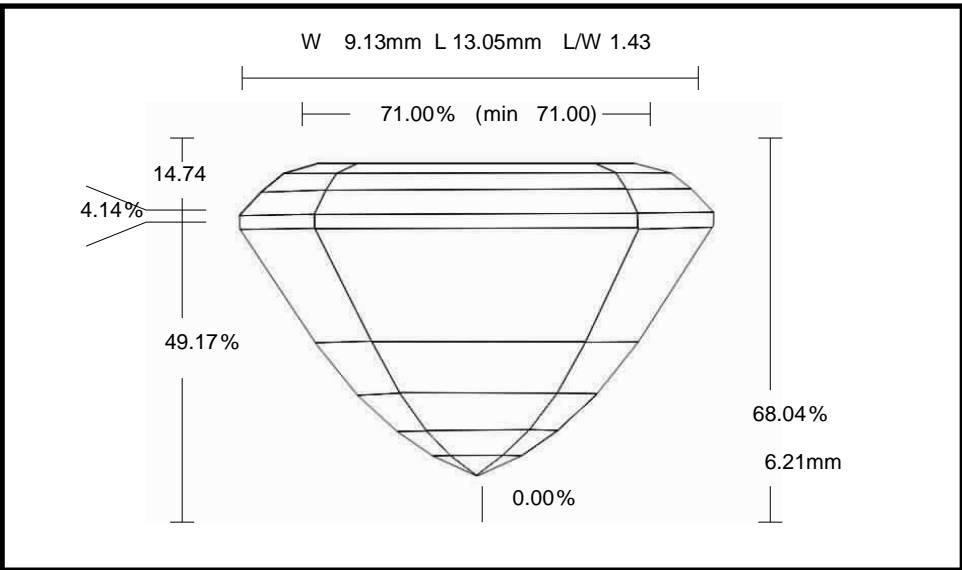

Parameter		Avg	Min	Max	Dev
Crown Angle 1	%	36.86	36.59	37.13	0.54
Crown Height	%	14.74	14.33	15.63	1.30
Girdle Thickness	%	4.14	3.91	4.35	0.44
Pavilion Angle 1 (Main)	%	57.70	57.69	57.71	0.02
Pavilion Height	%	49.17	48.22	49.80	1.58