

-

Stone No 72137

Shape EMERALD

Real Weight 11.71 (Ct)

Width 10.27 (mm)

Length 16.83 (mm)

Total Height 66.06 (%) 6.790(mm)

Table 72.00 (%) 7.360(mm)

L/W Ratio 1.64

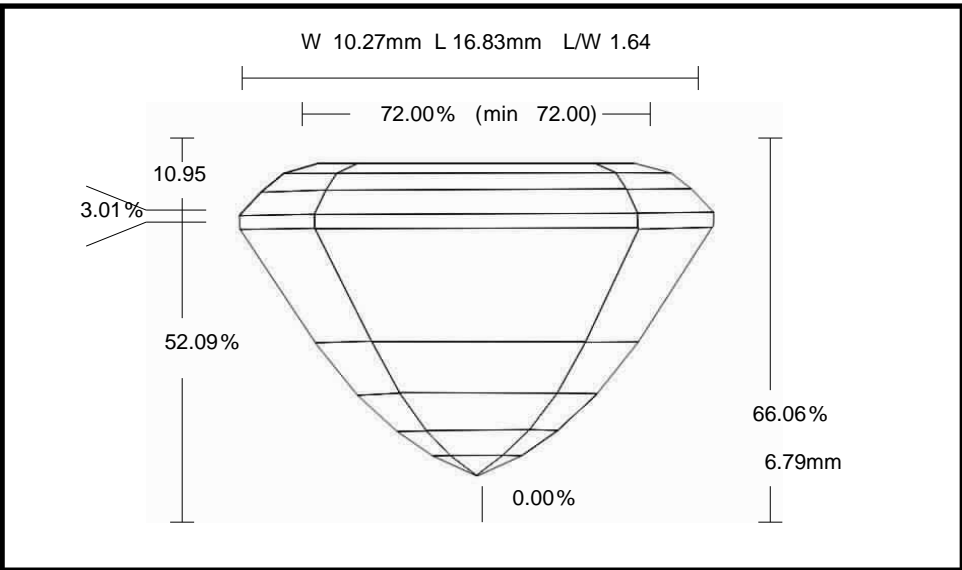

Parameter		Avg	Min	Max	Dev
Crown Angle 1	%	25.34	24.90	25.78	0.88
Crown Height	%	10.95	10.41	11.29	0.88
Girdle Thickness	%	3.01	2.85	3.19	0.34
Pavilion Angle 1 (Main)	%	58.30	58.09	58.52	0.43
Pavilion Height	%	52.09	51.71	52.45	0.74