

-

Stone No 72060

Shape EMERALD

Real Weight 13.67 (Ct)

Width 10.93 (mm)

Length 17.65 (mm)

Total Height 63.41 (%) 6.930(mm)

Table 68.00 (%) 7.470(mm)

L/W Ratio 1.62

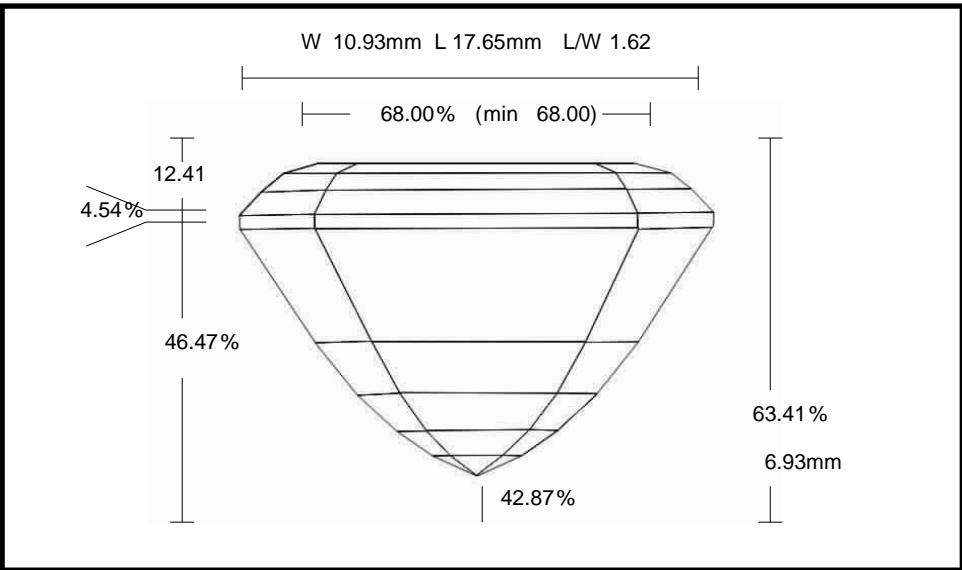

Parameter		Avg	Min	Max	Dev
Crown Angle 1	%	25.48	25.44	25.52	0.08
Crown Height	%	12.41	11.76	13.11	1.35
Girdle Thickness	%	4.54	3.99	5.09	1.10
Pavilion Angle 1 (Main)	%	57.08	57.05	57.11	0.06
Pavilion Height	%	46.47	45.85	46.81	0.96