

-

Stone No 72058

Shape EMERALD

Real Weight 13.25 (Ct)

Width 10.55 (mm)

Length 16.80 (mm)

Total Height 68.01 (%) 7.170(mm)

Table 66.00 (%) 6.930(mm)

L/W Ratio 1.59

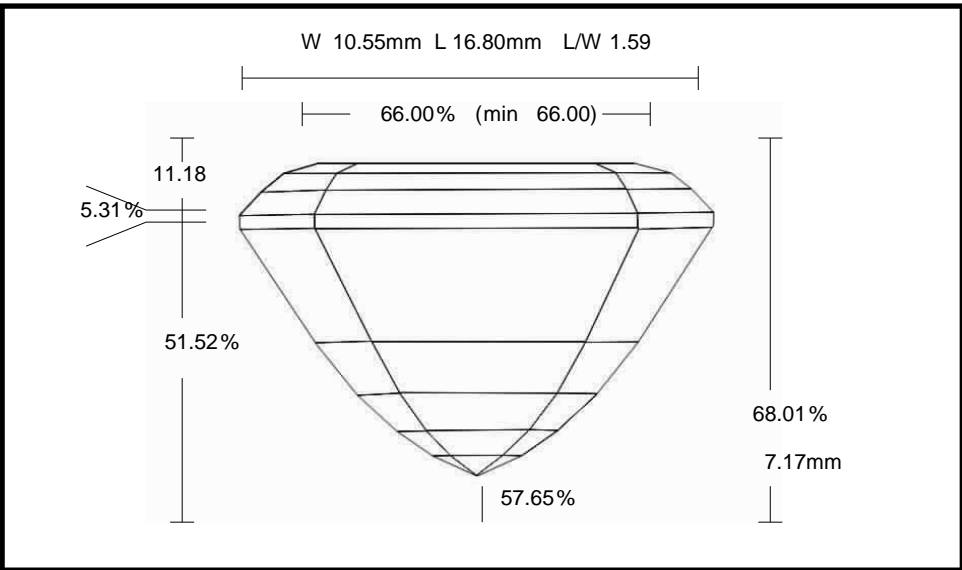

Parameter		Avg	Min	Max	Dev
Crown Angle 1	%	21.97	21.31	22.63	1.32
Crown Height	%	11.18	10.96	11.34	0.38
Girdle Thickness	%	5.31	4.98	5.63	0.65
Pavilion Angle 1 (Main)	%	60.00	59.99	60.01	0.02
Pavilion Height	%	51.52	51.31	51.69	0.38