

-

Stone No 72047
Shape EMERALD
Real Weight 7.79 (Ct)
Width 8.87 (mm)
Length 14.21 (mm)
Total Height 69.68 (%) 6.180(mm)
Table 62.00 (%) 5.500(mm)
L/W Ratio 1.60

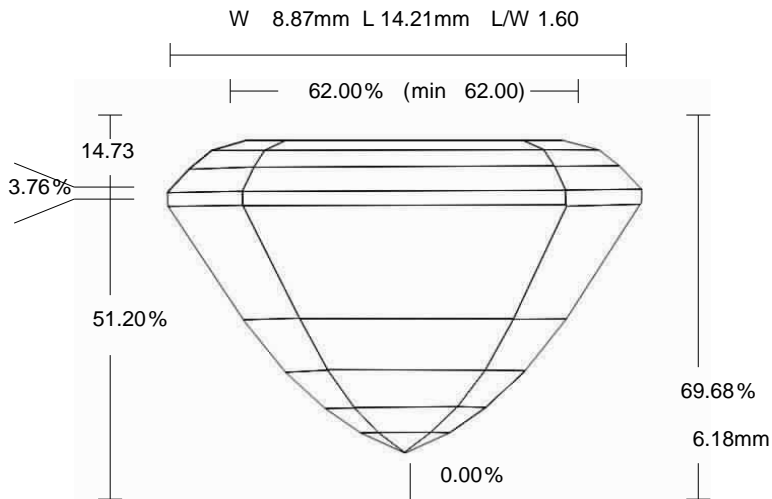

Parameter		Avg	Min	Max	Dev
Crown Angle 1	%	32.41	32.05	32.78	0.73
Crown Height	%	14.73	14.52	14.93	0.41
Girdle Thickness	%	3.76	3.34	3.99	0.65
Pavilion Angle 1 (Main)	%	58.87	58.52	59.22	0.70
Pavilion Height	%	51.20	50.79	51.78	0.99