

-

Stone No 72020

Shape EMERALD

Real Weight 11.22 (Ct)

Width 9.84 (mm)

Length 16.28 (mm)

Total Height 69.15 (%) 6.810(mm)

Table 72.00 (%) 7.080(mm)

L/W Ratio 1.65

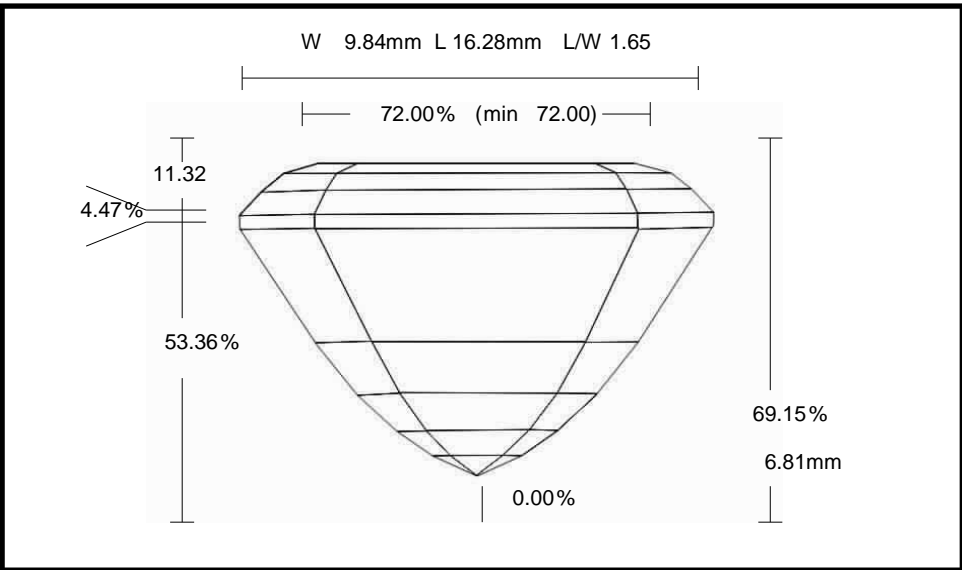

| Parameter | | Avg | Min | Max | Dev |
|--------------------------------|---|-------|-------|-------|------|
| Crown Angle 1 | % | 27.93 | 27.54 | 28.33 | 0.79 |
| Crown Height | % | 11.32 | 10.81 | 12.01 | 1.20 |
| Girdle Thickness | % | 4.47 | 3.91 | 4.99 | 1.08 |
| Pavilion Angle 1 (Main) | % | 59.76 | 59.73 | 59.79 | 0.06 |
| Pavilion Height | % | 53.36 | 52.51 | 54.06 | 1.55 |