

-

Stone No 72004

Shape EMERALD

Real Weight 11.94 (Ct)

Width 10.84 (mm)

Length 15.39 (mm)

Total Height 65.78 (%) 7.130(mm)

Table 68.00 (%) 7.390(mm)

L/W Ratio 1.42

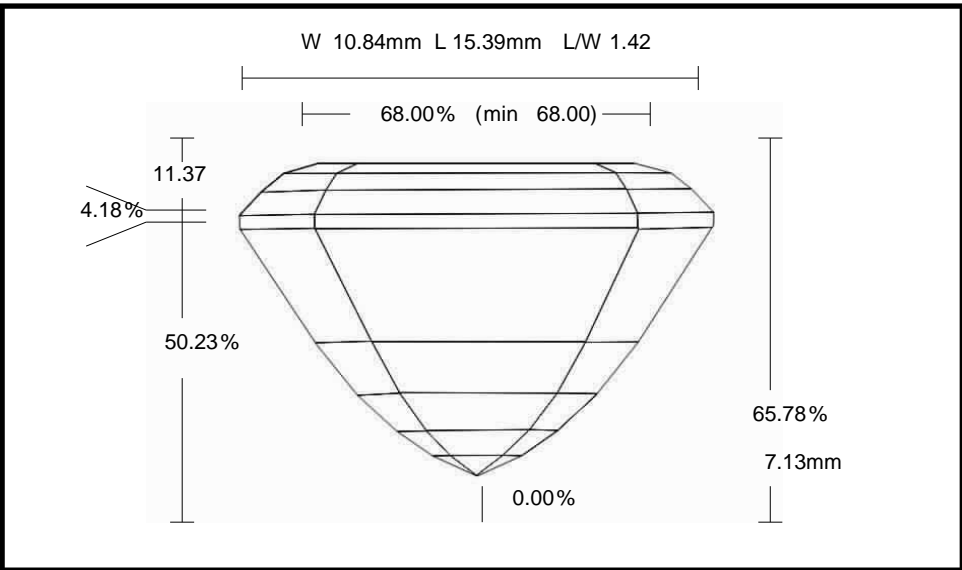

Parameter		Avg	Min	Max	Dev
Crown Angle 1	%	21.85	21.72	21.98	0.26
Crown Height	%	11.37	11.20	11.46	0.26
Girdle Thickness	%	4.18	4.11	4.25	0.14
Pavilion Angle 1 (Main)	%	59.19	59.07	59.30	0.23
Pavilion Height	%	50.23	50.09	50.46	0.37