

-

**Stone No** 71978

**Shape** EMERALD

**Real Weight** 12.50 ( Ct )

**Width** 10.23 ( mm )

**Length** 16.57 ( mm )

**Total Height** 69.20 (%) 7.080(mm)

**Table** 67.00 (%) 6.830(mm)

**L/W Ratio** 1.62

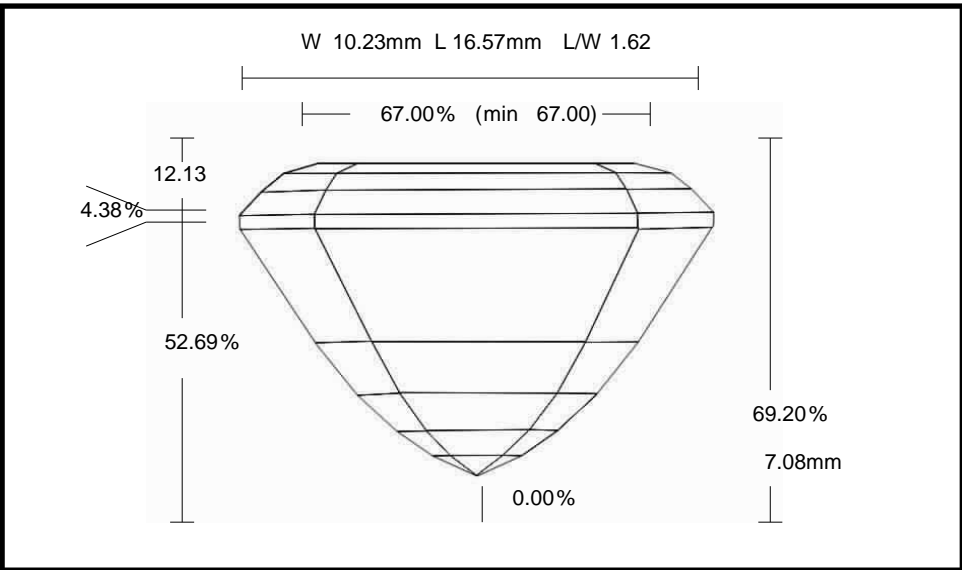

Parameter		Avg	Min	Max	Dev
<b>Crown Angle 1</b>	%	24.57	24.29	24.86	0.57
<b>Crown Height</b>	%	12.13	11.83	12.59	0.76
<b>Girdle Thickness</b>	%	4.38	4.18	4.65	0.47
<b>Pavilion Angle 1 (Main)</b>	%	60.84	60.55	61.14	0.59
<b>Pavilion Height</b>	%	52.69	52.13	53.19	1.06