

-

Stone No 71977
Shape EMERALD
Real Weight 7.63 (Ct)
Width 8.69 (mm)
Length 14.28 (mm)
Total Height 69.58 (%) 6.050(mm)
Table 60.00 (%) 5.240(mm)
L/W Ratio 1.64

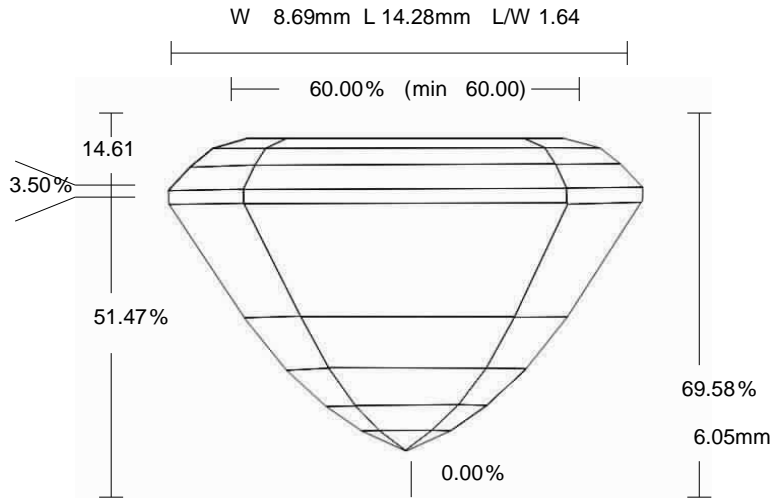

Parameter		Avg	Min	Max	Dev
Crown Angle 1	%	28.84	28.07	29.62	1.55
Crown Height	%	14.61	14.38	14.88	0.50
Girdle Thickness	%	3.50	3.31	3.66	0.35
Pavilion Angle 1 (Main)	%	59.47	59.16	59.79	0.63
Pavilion Height	%	51.47	51.04	51.72	0.68