

-

**Stone No** 71962

**Shape** EMERALD

**Real Weight** 12.55 ( Ct )

**Width** 10.54 ( mm )

**Length** 17.27 ( mm )

**Total Height** 63.79 (%) 6.720(mm)

**Table** 66.00 (%) 7.000(mm)

**L/W Ratio** 1.64

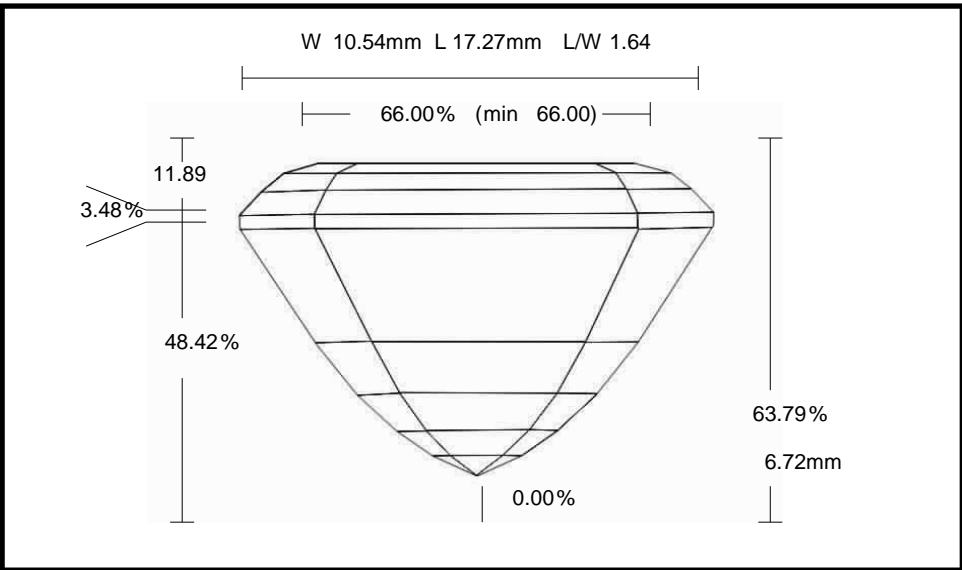

Parameter		Avg	Min	Max	Dev
<b>Crown Angle 1</b>	%	24.54	24.48	24.60	0.12
<b>Crown Height</b>	%	11.89	11.68	12.13	0.45
<b>Girdle Thickness</b>	%	3.48	3.35	3.64	0.29
<b>Pavilion Angle 1 (Main)</b>	%	57.59	57.39	57.79	0.40
<b>Pavilion Height</b>	%	48.42	48.21	48.77	0.56