

-

**Stone No** 71952

**Shape** EMERALD

**Real Weight** 11.58 ( Ct )

**Width** 10.22 ( mm )

**Length** 16.94 ( mm )

**Total Height** 63.55 (%) 6.500(mm)

**Table** 65.00 (%) 6.700(mm)

**L/W Ratio** 1.66

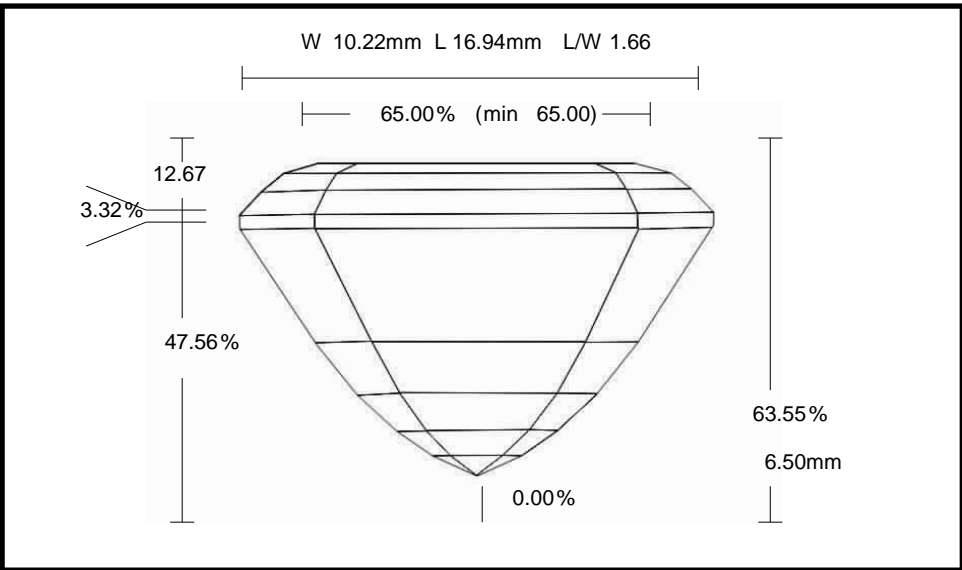

Parameter		Avg	Min	Max	Dev
<b>Crown Angle 1</b>	%	23.88	23.87	23.88	0.01
<b>Crown Height</b>	%	12.67	12.28	12.90	0.62
<b>Girdle Thickness</b>	%	3.32	3.06	3.44	0.38
<b>Pavilion Angle 1 (Main)</b>	%	59.14	59.00	59.29	0.29
<b>Pavilion Height</b>	%	47.56	47.22	47.89	0.67