

-

Stone No 71895

Shape EMERALD

Real Weight 9.26 (Ct)

Width 9.71 (mm)

Length 14.04 (mm)

Total Height 67.88 (%) 6.590(mm)

Table 64.00 (%) 6.230(mm)

L/W Ratio 1.45

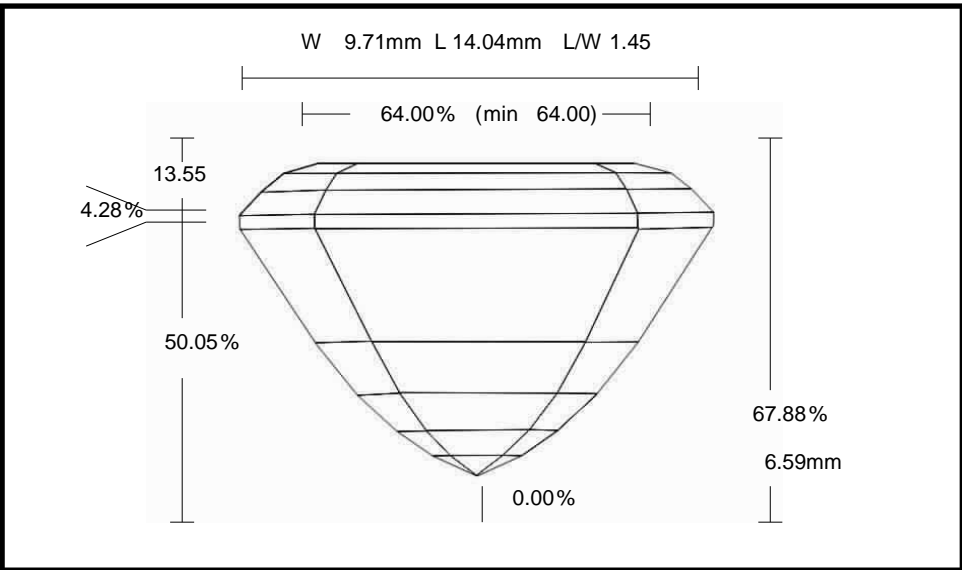

Parameter		Avg	Min	Max	Dev
Crown Angle 1	%	26.48	26.09	26.87	0.78
Crown Height	%	13.55	13.39	13.66	0.27
Girdle Thickness	%	4.28	3.99	4.59	0.60
Pavilion Angle 1 (Main)	%	60.37	60.36	60.38	0.02
Pavilion Height	%	50.05	49.81	50.25	0.44