

-

Stone No 71891

Shape EMERALD

Real Weight 7.63 (Ct)

Width 8.60 (mm)

Length 14.27 (mm)

Total Height 69.67 (%) 5.990(mm)

Table 60.00 (%) 5.160(mm)

L/W Ratio 1.66

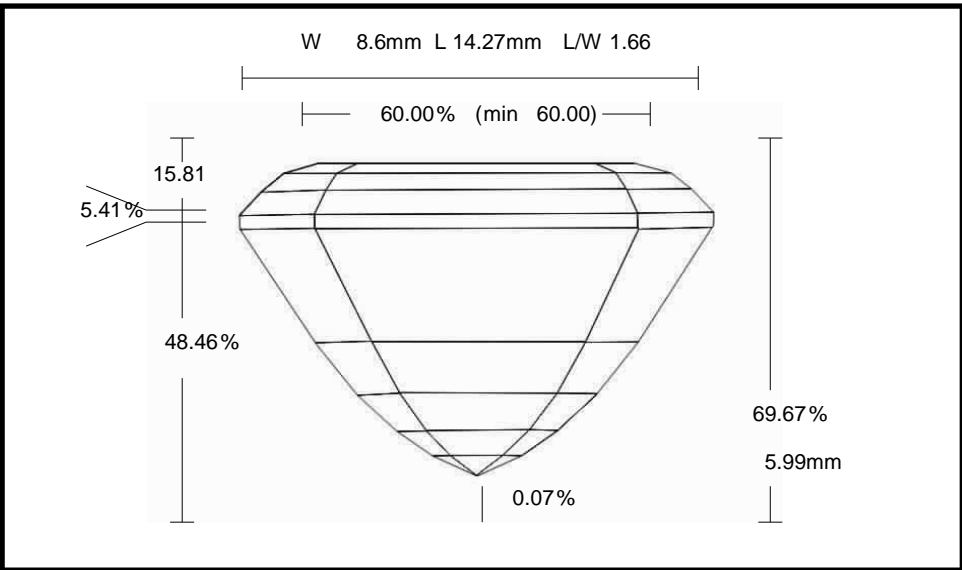

Parameter		Avg	Min	Max	Dev
Crown Angle 1	%	28.21	27.86	28.55	0.69
Crown Height	%	15.81	15.43	15.97	0.54
Girdle Thickness	%	5.41	5.31	5.56	0.25
Pavilion Angle 1 (Main)	%	58.13	57.65	58.61	0.96
Pavilion Height	%	48.46	48.21	48.93	0.72