

-

Stone No 71889

Shape EMERALD

Real Weight 12.50 (Ct)

Width 10.47 (mm)

Length 17.33 (mm)

Total Height 62.93 (%) 6.590(mm)

Table 69.00 (%) 7.210(mm)

L/W Ratio 1.66

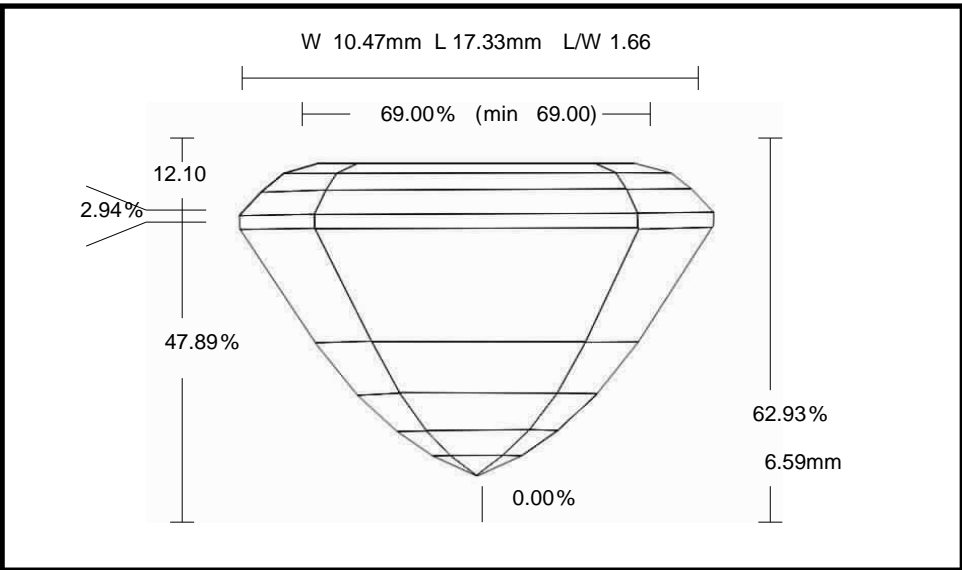

Parameter		Avg	Min	Max	Dev
Crown Angle 1	%	23.71	23.60	23.82	0.22
Crown Height	%	12.10	12.02	12.26	0.24
Girdle Thickness	%	2.94	2.80	3.06	0.26
Pavilion Angle 1 (Main)	%	59.89	59.75	60.04	0.29
Pavilion Height	%	47.89	47.78	48.01	0.23