

-

Stone No 71866

Shape EMERALD

Real Weight 8.54 (Ct)

Width 9.31 (mm)

Length 15.02 (mm)

Total Height 64.44 (%) 6.000(mm)

Table 66.00 (%) 6.180(mm)

L/W Ratio 1.61

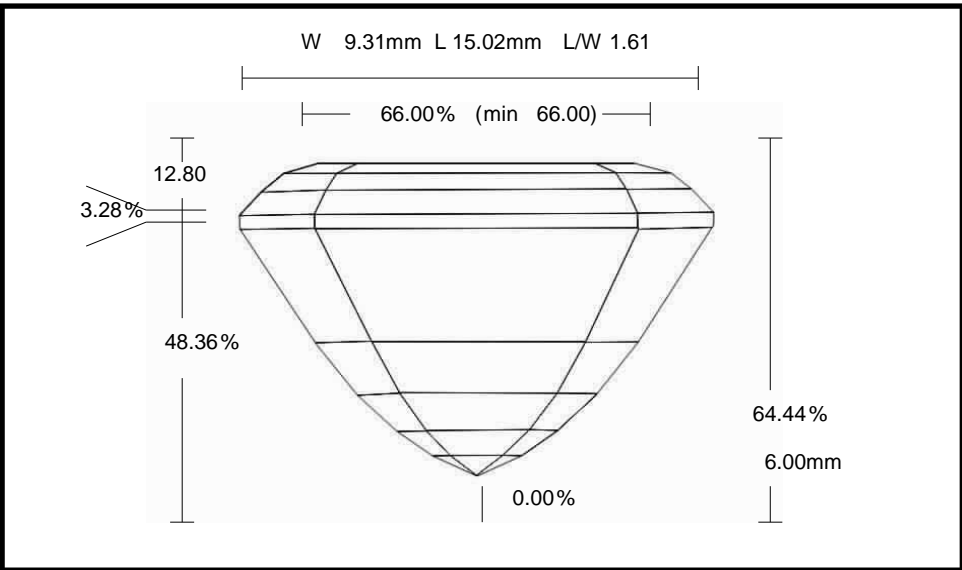

Parameter		Avg	Min	Max	Dev
Crown Angle 1	%	29.86	29.44	30.29	0.85
Crown Height	%	12.80	12.34	13.03	0.69
Girdle Thickness	%	3.28	3.06	3.67	0.61
Pavilion Angle 1 (Main)	%	57.51	57.48	57.54	0.06
Pavilion Height	%	48.36	48.28	48.44	0.16