

-

Stone No 71857

Shape EMERALD

Real Weight 7.85 (Ct)

Width 8.69 (mm)

Length 14.14 (mm)

Total Height 69.80 (%) 6.060(mm)

Table 66.00 (%) 5.720(mm)

L/W Ratio 1.63

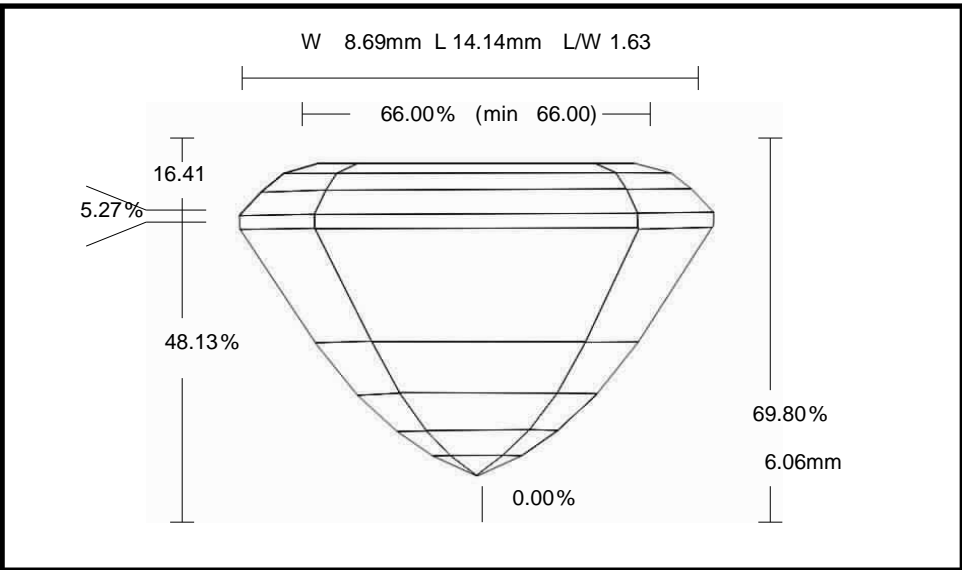

Parameter		Avg	Min	Max	Dev
Crown Angle 1	%	35.42	35.22	35.63	0.41
Crown Height	%	16.41	15.75	17.35	1.60
Girdle Thickness	%	5.27	5.06	5.84	0.78
Pavilion Angle 1 (Main)	%	58.19	57.69	58.68	0.99
Pavilion Height	%	48.13	47.37	48.93	1.56