

-

Stone No 71796

Shape EMERALD

Real Weight 7.19 (Ct)

Width 8.58 (mm)

Length 13.93 (mm)

Total Height 69.15 (%) 5.930(mm)

Table 58.00 (%) 4.950(mm)

L/W Ratio 1.62

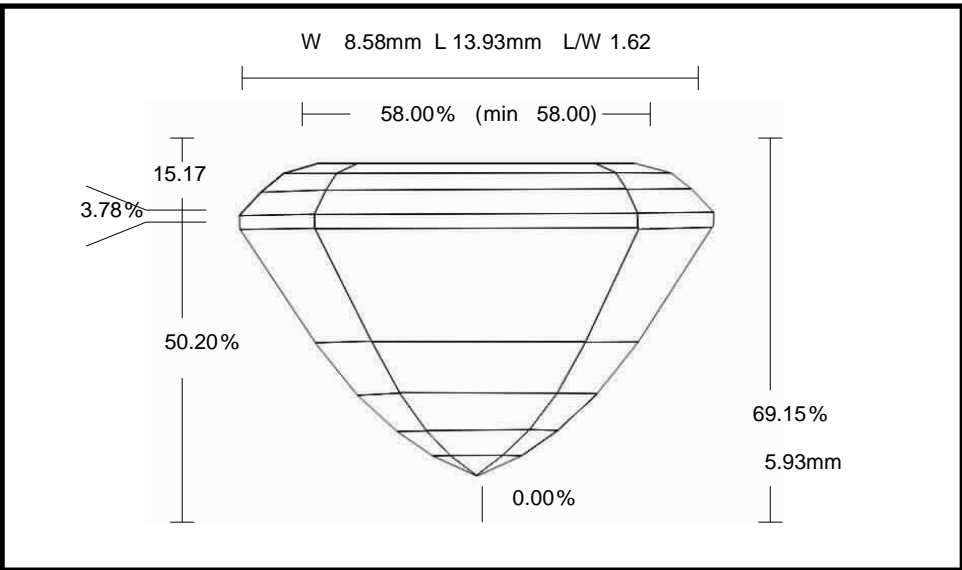

Parameter		Avg	Min	Max	Dev
Crown Angle 1	%	23.06	22.56	23.55	0.99
Crown Height	%	15.17	15.03	15.33	0.30
Girdle Thickness	%	3.78	3.67	3.89	0.22
Pavilion Angle 1 (Main)	%	58.50	58.19	58.80	0.61
Pavilion Height	%	50.20	50.12	50.23	0.11