

-

Stone No 71786

Shape EMERALD

Real Weight 12.24 (Ct)

Width 10.39 (mm)

Length 17.15 (mm)

Total Height 64.21 (%) 6.670(mm)

Table 69.00 (%) 7.120(mm)

L/W Ratio 1.65

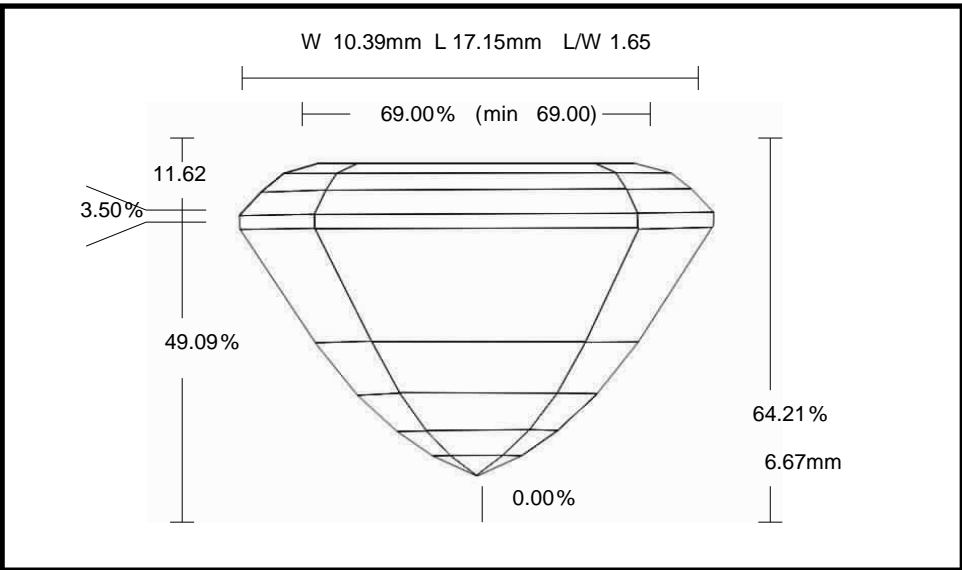

Parameter		Avg	Min	Max	Dev
Crown Angle 1	%	26.70	26.61	26.80	0.19
Crown Height	%	11.62	11.24	12.01	0.77
Girdle Thickness	%	3.50	3.36	3.67	0.31
Pavilion Angle 1 (Main)	%	58.53	58.36	58.69	0.33
Pavilion Height	%	49.09	48.53	49.51	0.98