

-

Stone No 71763

Shape EMERALD

Real Weight 9.93 (Ct)

Width 9.50 (mm)

Length 15.60 (mm)

Total Height 68.80 (%) 6.540(mm)

Table 64.00 (%) 6.120(mm)

L/W Ratio 1.64

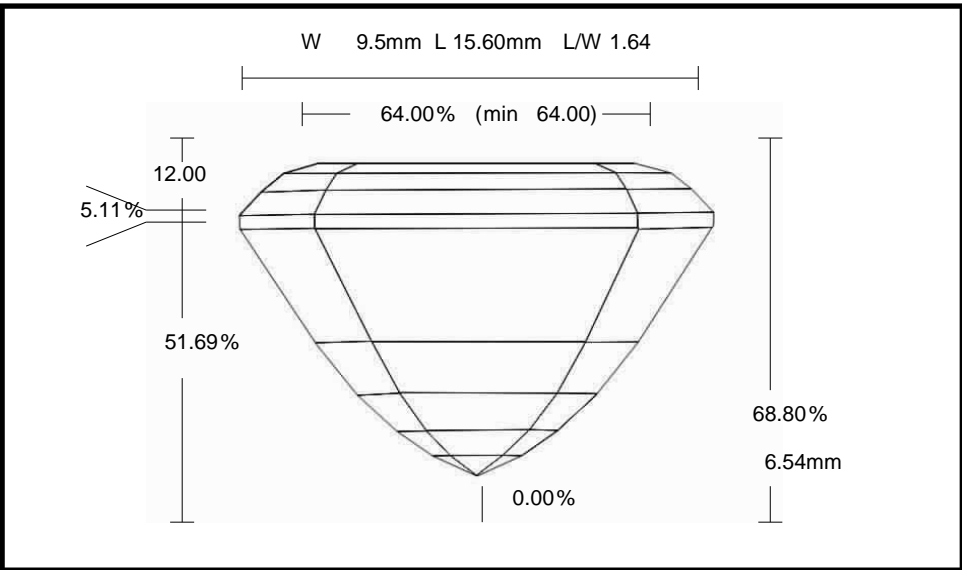

Parameter		Avg	Min	Max	Dev
Crown Angle 1	%	23.18	22.73	23.63	0.90
Crown Height	%	12.00	11.73	12.21	0.48
Girdle Thickness	%	5.11	4.74	5.30	0.56
Pavilion Angle 1 (Main)	%	59.09	58.70	59.48	0.78
Pavilion Height	%	51.69	51.30	51.99	0.69