

-

Stone No 71740

Shape EMERALD

Real Weight 11.36 (Ct)

Width 10.12 (mm)

Length 16.56 (mm)

Total Height 65.71 (%) 6.650(mm)

Table 63.00 (%) 6.390(mm)

L/W Ratio 1.64

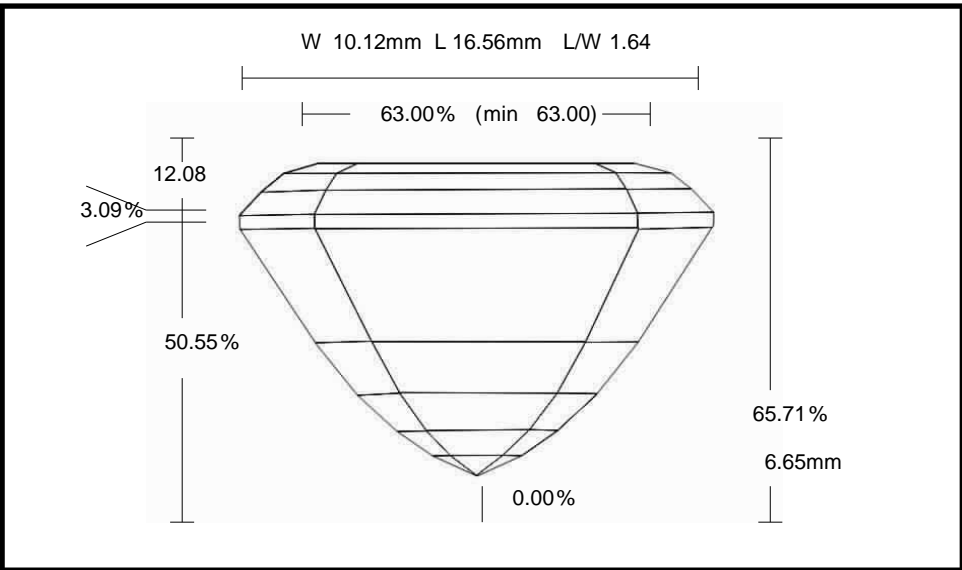

Parameter		Avg	Min	Max	Dev
Crown Angle 1	%	20.07	19.91	20.23	0.32
Crown Height	%	12.08	11.88	12.17	0.29
Girdle Thickness	%	3.09	1.98	3.68	1.70
Pavilion Angle 1 (Main)	%	59.55	59.21	59.89	0.68
Pavilion Height	%	50.55	49.88	51.85	1.97