

-

Stone No 71716
Shape EMERALD
Real Weight 11.53 (Ct)
Width 10.38 (mm)
Length 16.43 (mm)
Total Height 64.65 (%) 6.710(mm)
Table 74.00 (%) 7.690(mm)
L/W Ratio 1.58

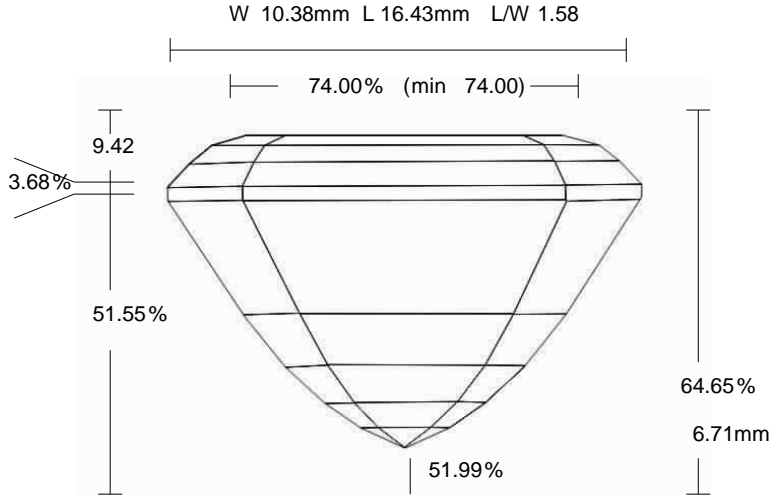

Parameter		Avg	Min	Max	Dev
Crown Angle 1	%	19.58	18.12	21.03	2.91
Crown Height	%	9.42	9.34	9.48	0.14
Girdle Thickness	%	3.68	3.25	4.07	0.82
Pavilion Angle 1 (Main)	%	58.60	58.40	58.81	0.41
Pavilion Height	%	51.55	51.11	51.98	0.87