

-

**Stone No** 71707

**Shape** EMERALD

**Real Weight** 11.67 ( Ct )

**Width** 10.27 ( mm )

**Length** 16.80 ( mm )

**Total Height** 63.84 (%) 6.560(mm)

**Table** 69.00 (%) 7.050(mm)

**L/W Ratio** 1.64

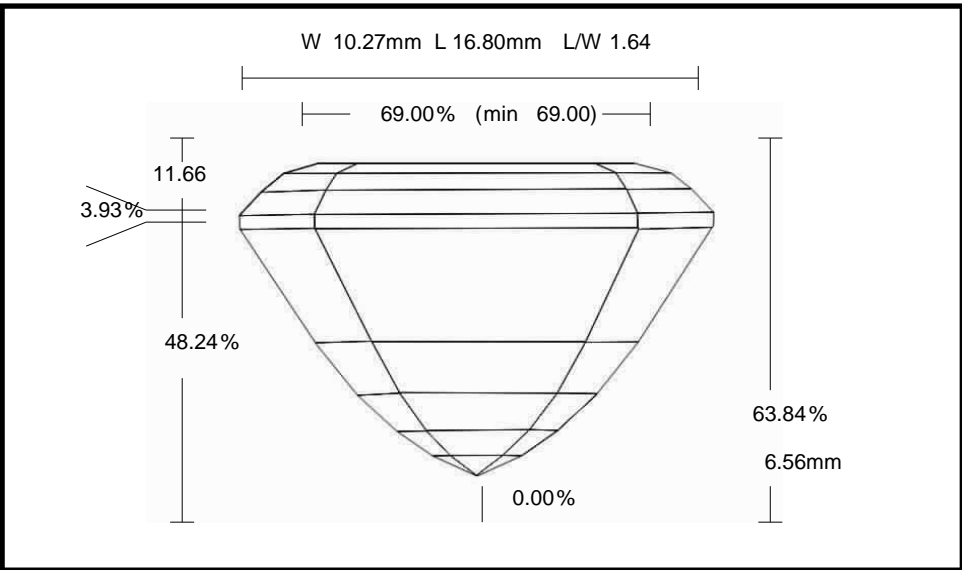

Parameter		Avg	Min	Max	Dev
<b>Crown Angle 1</b>	%	26.51	26.47	26.56	0.09
<b>Crown Height</b>	%	11.66	11.55	11.82	0.27
<b>Girdle Thickness</b>	%	3.93	3.75	4.05	0.30
<b>Pavilion Angle 1 (Main)</b>	%	58.31	58.26	58.35	0.09
<b>Pavilion Height</b>	%	48.24	48.03	48.48	0.45