

-

**Stone No** 71706

**Shape** EMERALD

**Real Weight** 9.28 ( Ct )

**Width** 9.43 ( mm )

**Length** 15.17 ( mm )

**Total Height** 68.02 (%) 6.420(mm)

**Table** 66.00 (%) 6.230(mm)

**L/W Ratio** 1.61

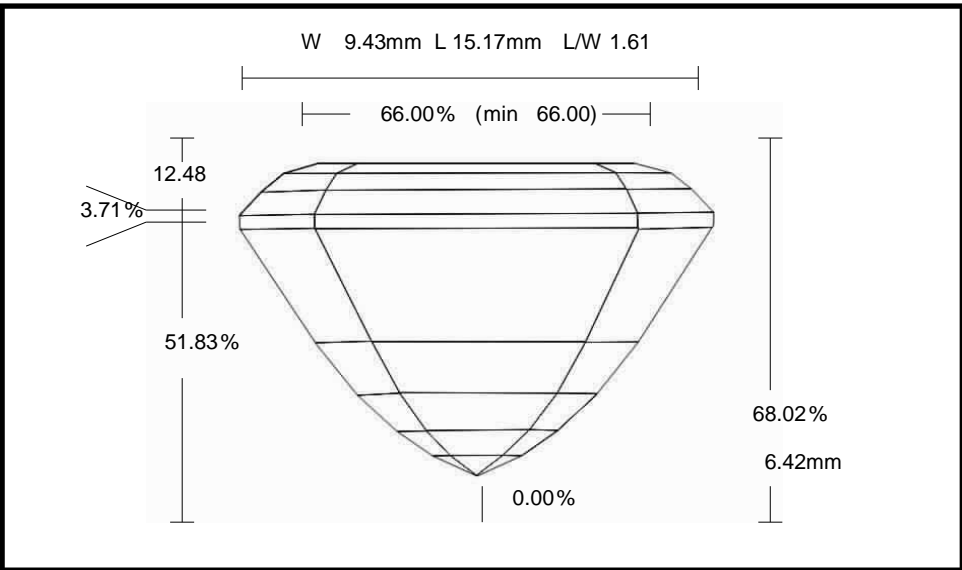

Parameter		Avg	Min	Max	Dev
<b>Crown Angle 1</b>	%	23.04	22.82	23.27	0.45
<b>Crown Height</b>	%	12.48	12.29	12.67	0.38
<b>Girdle Thickness</b>	%	3.71	3.62	3.76	0.14
<b>Pavilion Angle 1 (Main)</b>	%	59.31	58.94	59.68	0.74
<b>Pavilion Height</b>	%	51.83	51.61	52.02	0.41