

-

Stone No 71703

Shape EMERALD

Real Weight 11.58 (Ct)

Width 10.14 (mm)

Length 16.75 (mm)

Total Height 64.87 (%) 6.580(mm)

Table 66.00 (%) 6.730(mm)

L/W Ratio 1.65

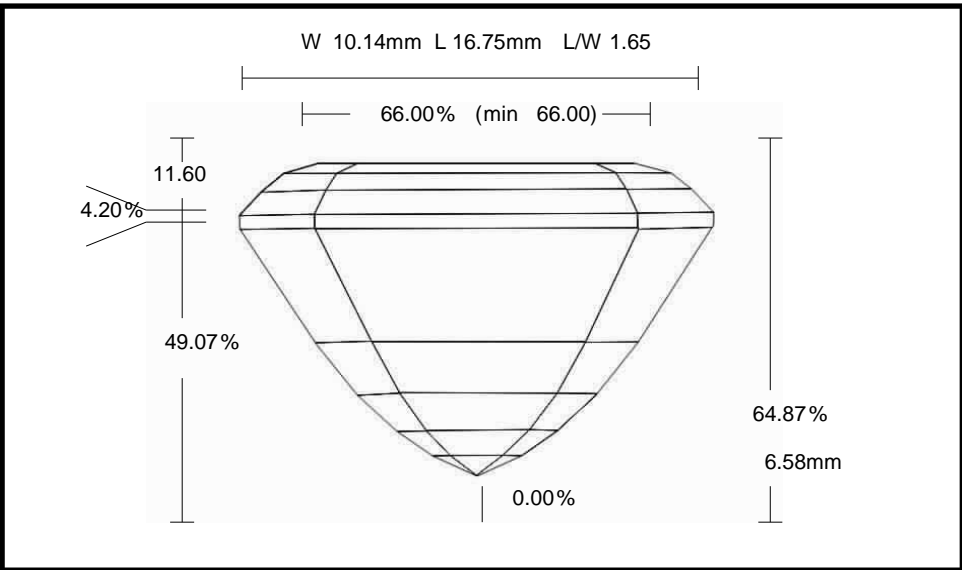

Parameter		Avg	Min	Max	Dev
Crown Angle 1	%	22.53	22.35	22.71	0.36
Crown Height	%	11.60	11.26	11.77	0.51
Girdle Thickness	%	4.20	3.83	4.79	0.96
Pavilion Angle 1 (Main)	%	59.11	59.11	59.11	0.00
Pavilion Height	%	49.07	48.40	49.51	1.11