

-

Stone No 71625

Shape EMERALD

Real Weight 9.92 (Ct)

Width 9.63 (mm)

Length 15.38 (mm)

Total Height 67.65 (%) 6.510(mm)

Table 67.00 (%) 6.470(mm)

L/W Ratio 1.60

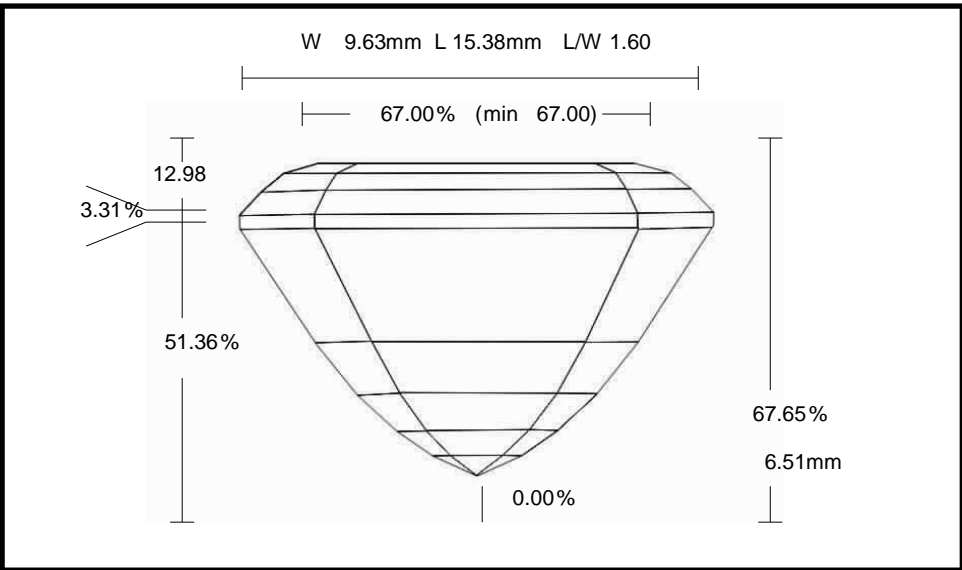

Parameter		Avg	Min	Max	Dev
Crown Angle 1	%	27.38	27.32	27.44	0.12
Crown Height	%	12.98	12.88	13.05	0.17
Girdle Thickness	%	3.31	3.13	3.56	0.43
Pavilion Angle 1 (Main)	%	61.17	61.14	61.20	0.06
Pavilion Height	%	51.36	51.09	51.49	0.40