

-

Stone No 71595

Shape EMERALD

Real Weight 7.67 (Ct)

Width 8.72 (mm)

Length 14.32 (mm)

Total Height 68.86 (%) 6.010(mm)

Table 69.00 (%) 5.970(mm)

L/W Ratio 1.64

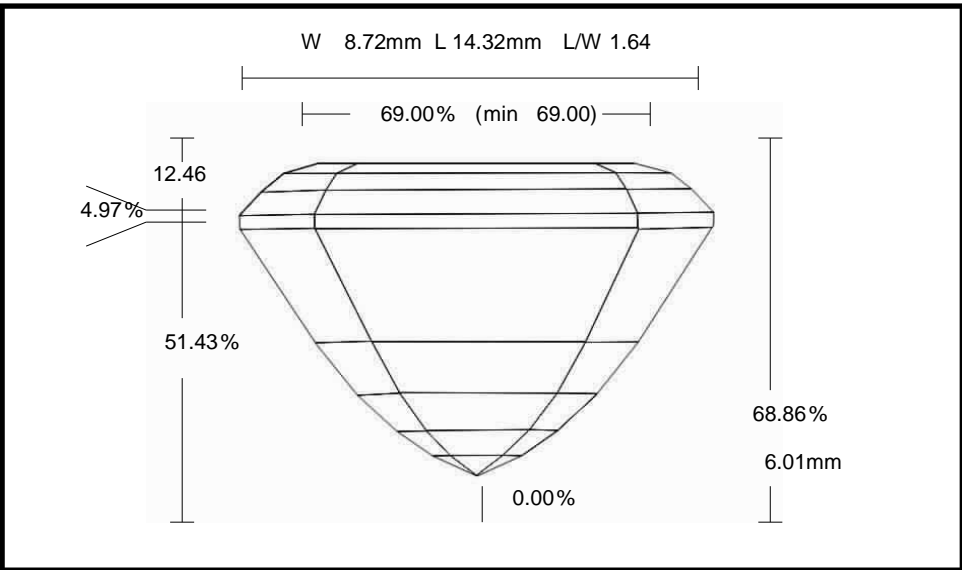

Parameter		Avg	Min	Max	Dev
Crown Angle 1	%	27.37	27.21	27.53	0.32
Crown Height	%	12.46	12.39	12.50	0.11
Girdle Thickness	%	4.97	4.91	5.03	0.12
Pavilion Angle 1 (Main)	%	57.87	57.75	57.98	0.23
Pavilion Height	%	51.43	51.33	51.50	0.17