

-

Stone No 71092

Shape EMERALD

Real Weight 8.62 (Ct)

Width 9.08 (mm)

Length 14.68 (mm)

Total Height 69.52 (%) 6.310(mm)

Table 62.00 (%) 5.590(mm)

L/W Ratio 1.62

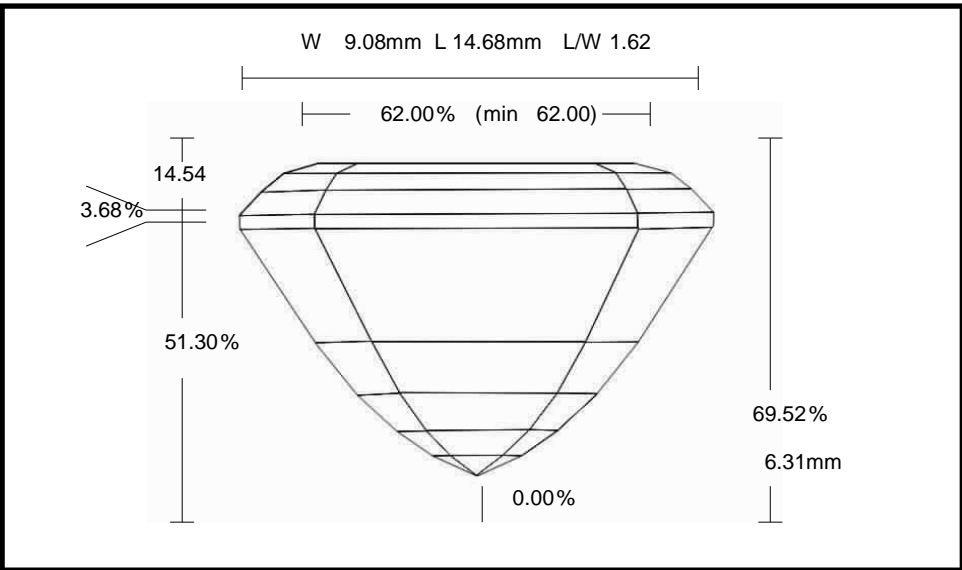

Parameter		Avg	Min	Max	Dev
Crown Angle 1	%	24.47	24.23	24.70	0.47
Crown Height	%	14.54	14.08	14.87	0.79
Girdle Thickness	%	3.68	3.29	4.07	0.78
Pavilion Angle 1 (Main)	%	60.11	59.98	60.24	0.26
Pavilion Height	%	51.30	50.77	51.69	0.92